

- Trace (ppm) to % level Oxygen measurement in gas & liquid applications
- Measurement accuracy, drift and lifetime not affected by presence of H₂S, CO₂, SO₂ and H₂
- Auto-Calibration & Remote Validation
 - Timer-based or user initiated (HMI or RS485)
 - Test Gas Insert (HMI or RS485)
- Rugged Field Enclosure - Local Display & HMI
 - IP66 & NEMA 4X
 - Through-the-glass keypad (no tools or permits required)
- Pressure Compensated Measurement
 - Ambient (on-board) pressure sensor
 - 4-20 mA active (loop powered input) for optional in-line pressure transmitter
- Works with BOSx FlexSense I, FlexSense II and SafeTap fiber optic oxygen sensors
 - Replaceable sensor caps (simple and cost effective)
- OXYvisor PC software for configuration, set-up, diagnostics and trending
- Hazardous Area Approvals
 - IEC Ex, ATEX, NA - Zone 1 & Zone 2 IIC
 - cULus (NRTL) - Class I, Div 2, Groups A, B, C, D T4



The OXYvisor optical oxygen Analyzer is Barben Analytical's next generation solution for oxygen measurement in industrial applications. When paired with the BOSx optical oxygen sensor's quenched luminescent technology, the OXYvisor provides the ability to measure oxygen in liquid and gas phase processes.

For more information on Barben Analytical's BOSx Oxygen Sensors and our sample conditioning panel products please refer to the separate data sheets for these products:

[Barben Optical Sensor \(BOSx\) - Data Sheet](#)

[Sample Calibration Panel - Data Sheet](#)



Typical Applications - Gas Phase (g)

- O₂ in hydrocarbon streams
 - Vapor recovery units (VRU's)
 - Gathering lines/headers
 - Gas plant inlets
 - Booster / compressor stations
 - Custody transfer points
 - Transmission and distribution
- Trace O₂ detection in nitrogen headers
- Biogas oxygen detection (moisture and H₂S)
- Pure ethylene and propylene production
- O₂ in nitrogen tank blanketing
- Trace to % level oxygen in syngas gas
- Annealing furnaces (H₂ and inert gases)

Note: Limit of Detection: 0.5 ppm O₂ @ 1atm, 20°C (0.0005 hPa)

Typical Applications - Liquid Phase (l)

- ppb dissolved O₂ for water-flood injection
- Produced water dissolved O₂
- Oxygen in methanol and ethanol
- Oxygen in oil separation
- O₂ in aqueous and non-aqueous solutions

Note: Limit of Detection: 1 ppb Dissolved O₂

Precision Optical Oxygen Measurement

OXYvisor™ Oxygen Analyzer

Principle of Operation

The OXYvisor analyzer uses an optical quench luminescence technology to measure process oxygen. Phase modulation of the luminescent decay time of an oxygen specific luminophore allows the calculation of the partial pressure of oxygen concentration within the process stream.

The analyzer uses an LED to emit blue light through fiber optic cable down to the luminophore at the sensor tip [Fig 1]. The luminophore absorbs the energy and rises to an excited state indicated by red light returned back through the fiber optic cable. The properties of the emitted light are measured through a photomultiplier tube back at the spectrometer within the analyzer.

In the absence of oxygen, the excited luminophore will fall back to its ground state at a specific intensity and phase angle. When oxygen is present it quenches the fluorescence at a lower rate proportional to the oxygen concentration [Fig 2.]. The phase shift and intensity differences between the excitation source and the fluorescent signal is measured and the oxygen concentration is calculated [Fig 3].

The resulting measurement is specific to oxygen concentration. The luminophore is unaffected by other contaminant gases and flow rate. The measurement is applicable in both gas and liquid phase. Temperature compensation is required to account for quenching efficiency at different temperatures and pressure compensation is required to measure the process pressure when different than the pressure at time of calibration.

Light transmission through fiber optic to luminophore

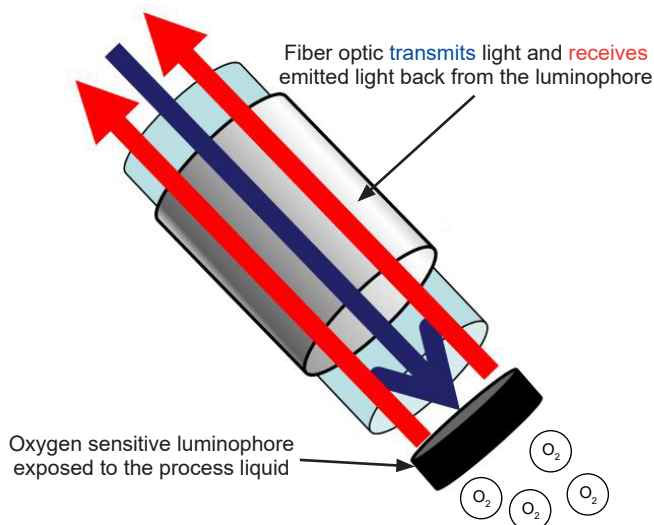
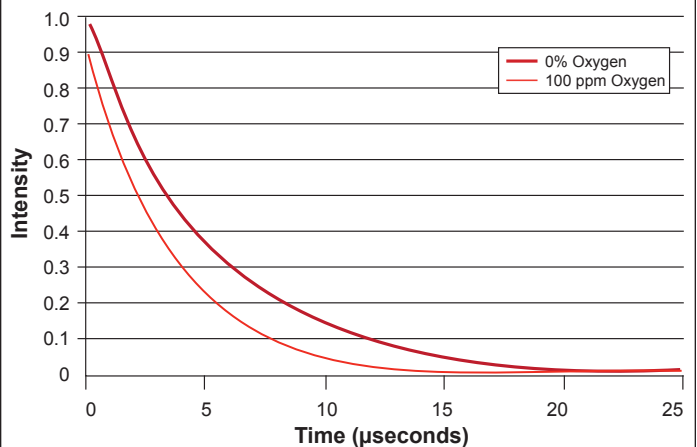

Figure 1

Effects of 100 ppm oxygen quenching



The affect of oxygen quenching on light intensity from the luminophore sensor is shown above. Light emitted from the excited luminophore has higher intensity over a longer time period than when oxygen is present. The intensity and time are measured by the spectrometer within the OXYvisor to provide an oxygen measurement.

Figure 2

AC modulation and the phase shifted output

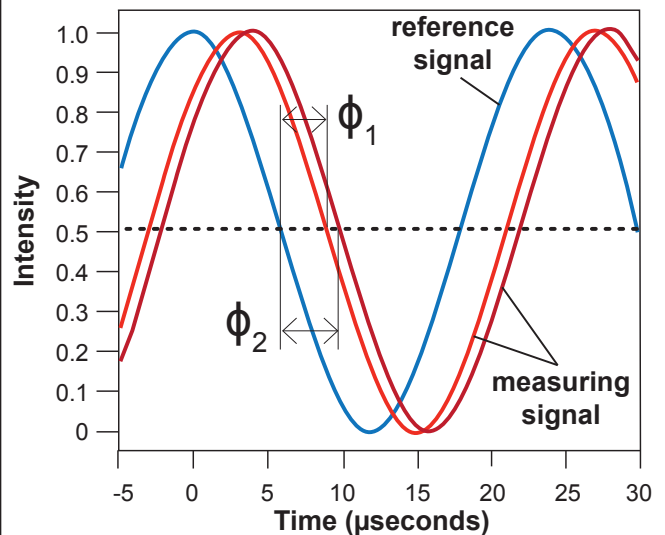

AC modulation of the blue light results in a similar waveform of the emitted red light from the luminophore sensor. The presence of oxygen causes a phase shift between ϕ_1 and ϕ_2 of the red light waveform. Measurement of this phase shift proportionally matches the loss of intensity shown in figure 2 above. The combination of both measurement techniques provides a stable, accurate method to measure oxygen in liquid and gas phase applications.

Figure 3

Precision Optical Oxygen Measurement

OXYvisor™ Oxygen Analyzer

OXYvisor Analyzer Features (Hardware/Firmware/Software)

HMI Touch Keys (thru-the-glass): Easy to use configuration and calibration menus can be accessed through a touch screen, infrared keypad, protected behind the analyzer window.

HMI LockOut Screen: HMI lockout screen prevents any unwanted HMI interaction with critters, debris, or maintenance technicians.

Sensor Connection Junction Box: Connection of the BOSx Optical Sensor is easily made through the junction box. In the rare case it is ever needed, this design allows for easy fiber optic sensor replacement, in the field, without exposing the electronics to dust, humidity or human error. Normally the fiber optic cable is installed once and the sensor cap is the standard replacement item.

Data-Logging (USB Port): A USB port within the rear compartment, can be used for downloading logs of measurement data, and diagnostic information. Historical time based Oxygen, phase angle, intensity, temperature and pressure measurement, along with error logs and calibration history is stored in .csv format and available for download via USB memory stick.

Programmable I / O: The OXYvisor comes with two analog outputs, four isolated digital relay outputs and, one analog input. All I / O's are fully user configurable (variable and range) through the keypad, software or RS485 Modbus. Additionally, an (active) digital input can be used to connect a customer supplied toggle switch or other external contact, to initiate AutoCal or test gas insert (REMOTE VALIDATION).

MODBUS RTU: All OXYvisor units have a standard MODBUS RS485 serial output. This 2-wire signal can be used to transmit measurement values, initiate automatic calibration of the device or software configuration of the analyzer.

Calibration Options: Several calibration options are available to best suit the customers installation and application requirements.

- **Factory Cal** provides quick startup without test gas. The calibration values found on the sensor certification sheet can be uploaded and good results can be expected. (We recommend to field validation for best results.)
- **Manual One-point** calibration with either zero or span gas, depending on the customer requirements.
- **Manual Two-point** calibration using zero and span gas (recommended for new users).
- **Auto-calibration (AutoCal)** logic in the OXYvisor firmware along with three on-board digital relays (passive) allows for complete AutoCal and validation with known test gases. The AutoCal logic allows user programming of time based calibration, gas selection and the hysteresis criteria for pass / fail evaluation. Auto-calibration requires: AutoCal SCP Panel or three user provided, powered, solenoids & test gases

On-Board Diagnostic Memory: The last ten calibrations as well as the last ten error messages are stored within the analyzer at all times and can be viewed through the firmware at the HMI or via PC software.

Security: If operator access control is required then each sub-menu can be locked out using a four digit security pass-code. These codes can be entered through the keypad or via the OXYvisor software.

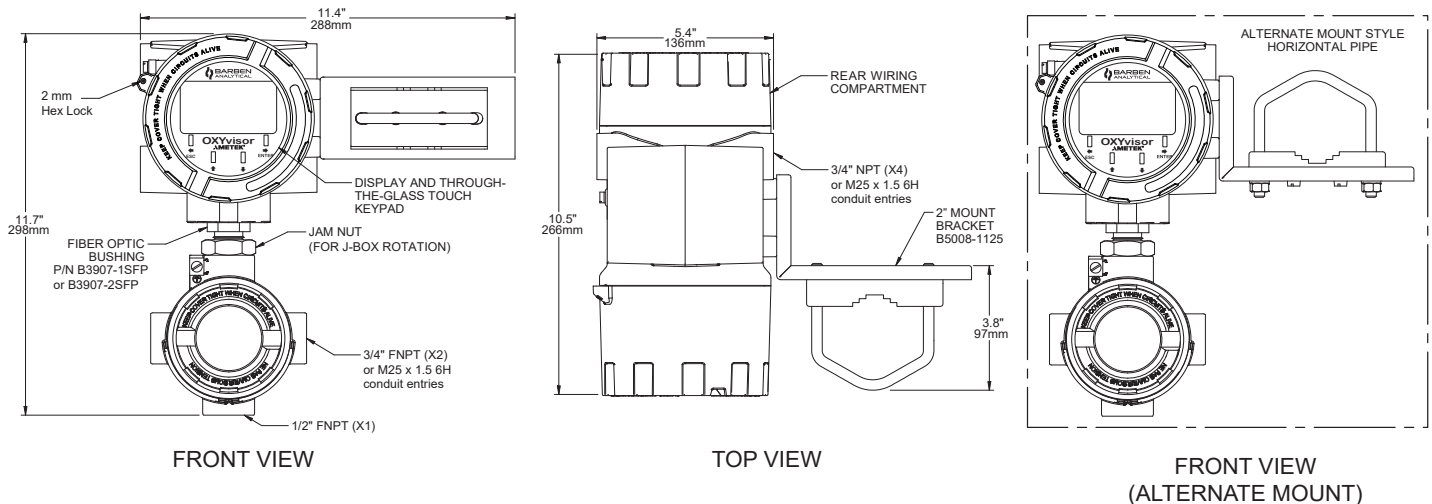



Figure 4

Precision Optical Oxygen Measurement

OXYvisor™ Oxygen Analyzer

Barben Oxygen Analyzer - OXYvisor Specifications

| OXYvisor Oxygen Analyzer Specifications | | |
|---|--|--|
| Power Supply - Selectable as AC or DC via Product Selection Nomenclature | | |
| AC Power |  | 85-264 VAC, 47-63 Hz, 6W (AC, "4-wire," line powered analyzer) |
| DC Power |  | 24 V DC +/-10% 5W (Class 2 / LPS source) (DC, "4-wire," line powered analyzer. Not a 2-wire loop powered transmitter) |
| Environmental | | |
| Operating Temperature | | -20 to +55°C (-4 to 131°F) |
| Storage Temperature | | -20 to +65°C (-4 to 149°F) |
| Max. Operating Relative Humidity | | 95%, non-condensing |
| Max Altitude | | Maximum altitude up to 2,000 meters (6,561 ft) |
| IEC | | IEC Installation Category II and Pollution Degree 2 |
| Physical | | |
| Main Enclosure and Junction Box | Ratings | IP66 and NEMA 4x, protected against dust and high pressure water ingress. Corrosion resistant. |
| | Material Type | Copper Free Aluminum Alloy, EN 1706 (DIN 1725), pressure die-casting, yellow chromated, chemically resistant polyurethane primer and coat. |
| | Conduit Entries | Main enclosure = QTY 4, junction box = QTY 2, 3/4" FNPT or M25 x 1.5 6H conduit entries |
| | O-Ring Seals | Silicone VMQ rubber |
| Dimensions H x W x D (combined) | | 12.0 x 5.5 x 11.0 inches (30.5 x 14.0 x 28 cm) |
| Weight (total/combined) | | 13.7 lb (6.2 kg) |
| Liquid Crystal Display | | Viewing = 79 (W) x 40 (H) mm, 240 x 128 dots, FSTN / Positive / Transflective |
| HMI Touch-Keys (through-the-glass) | | (4) proximity switches, infrared contacts for interactive user interface at HMI |
| Input Information | | |
| Sensor Inputs | Optical O₂ | (1) O ₂ optical input BOS1, BOS2 or BOS3 sensor (SMA connector) |
| | RTD - Temp | (1) Pt100 or Pt1000 4-wire RTD Inputs (isolated) |
| | Analog Input | (1) 4-20 mA input (24 Vdc active from OXYvisor) - User configurable for Temperature or Pressure transmitter |
| | Pressure Sensor | (1) On-board integrated pressure sensor measures and compensates for ambient pressure conditions |
| Digital Inputs | | (2) optically isolated inputs, 5 Vdc powered, remote initiation of automatic calibration and live validation gas |
| Output Information | | |
| Analog Outputs | | (2) Programmable current outputs with galvanic isolation, 4 to 20 mA (Active), Linear or Bi-Linear, 24 Vdc |
| Digital Outputs (Alarm/Relays) | | (4) Programmable relays, optically isolated, passive, 24Vdc, 0.05A pilot duty, 0.45 A general use/ resistive load. |
| Digital Communication | | (1) Modbus RTU serial protocol RS485 - Two way Communication |
| User Adjustable Options | | |
| Oxygen Units | <i>Gas Phase:</i> %O ₂ , ppm, hPa | <i>Liquid Phase:</i> ppm, ppb, hPa |
| Temperature Units | Fahrenheit or Celsius | |
| Pressure Units | mbar, inches H ₂ O, Bar and PSI (absolute pressure) | |
| Advanced Features | | |
| Automatic Calibration (AutoCal) | AutoCal logic controls 3 relays, user programmable with time based schedule or user initiated (requires AutoCal panel) | |
| Remote Validation (Test Gas Insert) | Test gas insert allows for remote or local validation with Test Gas (requires AutoCal panel) | |
| Auto-Sample Rate | Minimizes drift between calibrations, increases sensor lifetime without decreasing performance when needed | |
| Temperature Compensation | Automatic Temperature compensation to account for sensor output & used for DO calculation | |
| Pressure Compensation | Pressure compensates/corrects for concentration calculations due to ambient or process pressure changes | |
| Analog Input Calibration | Allows for correction/matching of Analog Input, either remote temperature or pressure transmitter | |
| Data & Error Logging Options | Last 10 error messages and calibrations time/date stamped (.pdf file), USB data trend storage (.csv file) | |
| OXYvisor PC Software | Configuration, programming, set-up, measurement, diagnostics, and trending (requires RS485 to USB cable) | |

Precision Optical Oxygen Measurement

OXYvisor™ Oxygen Analyzer

BOSx - Barben Oxygen Sensors (BOS1, BOS2 & BOS3)

Barben Oxygen Sensors (BOSx), are sold separately or as part of an integrated (SCP) package with the **OXYvisor**. The sensors consist of a fiber optic cable with SMA termination at one end, for connection to the OXYvisor, and the other end, integrated with an oxygen sensing luminophore to be placed into the process or sample stream. There are three BOSx sensor ranges, that can be used with the **OXYvisor**, BOS1, BOS2 and BOS3. Their selection and pairing with the **OXYvisor** will define the range, accuracy and repeatability of the **OXYvisor**. For additional information on BOSx sensors please refer to the BOSx sensor product data sheet.

| BOS1 Sensor Specifications - Liquid Phase / Gas Phase | | |
|--|---|--|
| | Dissolved Oxygen (DO) | Gas Phase @ 1atm, 20°C |
| Measurement Range | 0 - 2.0 mg/L (ppm) | 0 - 5.0% O ₂ (0 - 50.7 hPa) |
| Limit of Detection | 1.0 µg/L (ppb) | 0.002 % O ₂ (0.02 hPa) |
| Resolution @ 20°C and 1013 hPa | ± 0.30 at 1 µg/L (ppb) ± 0.63 at 200 µg/L (ppb) | ± 0.0007 % O ₂ at 0.002 % O ₂ , ± 0.0015 % O ₂ at 0.02 % O ₂ , ± 0.007 hPa at 0.023 hPa, ± 0.015 hPa at 2.0 hPa |
| Response Time (T₉₀) | < 30 sec. | < 6 sec. |
| Accuracy @ 20°C | 1 ppb (l), 0.002 % O ₂ (g), or 3% of the measured value whichever is greater | |
| Drift from Photo-decomposition | DO < 2 ppb and Gas Phase < 0.0042% O ₂ within 30 days (1 min sample rate) | |
| Operating Temperature Range | 0 to 50°C (32 to 122°F) continuous [for use >50 C, up to 70 C, consult factory for special conditions and considerations] | |
| Allowable Sensor Temperature | up to 90°C (194°F) non-continuous | |
| BOS2 Sensor Specifications - Liquid Phase / Gas Phase | | |
| | Dissolved Oxygen (DO) | Gas Phase @ 1atm, 20°C |
| Measurement Range | 0 - 45 mg/L (ppm) | 0 - 100 % O ₂ (0 - 1013 hPa) |
| Limit of Detection (LOD) | 15 ppb dissolved oxygen | 0.03 % O ₂ |
| Resolution @ 20°C and 1013 hPa | ± 4.5 at 90 µg/L (ppb) ± 0.15 at 23 mg/L (ppm) | ± 0.01 % O ₂ at 0.21 % O ₂ ± 0.1 hPa at 2 hPa ± 0.1 % O ₂ at 20.9 % O ₂ ± 1 hPa at 207 hPa |
| Response Time (T₉₀) | < 30 sec. | < 6 sec. |
| Accuracy @ 20°C | ± 0.4 % O ₂ at 20.9 % O ₂ , ± 0.05 % O ₂ at 0.2 % O ₂ | |
| Drift from Photo-decomposition | DO < 24 ppb and Gas Phase < 0.03% O ₂ within 30 days (1 min sample rate) | |
| Operating Temperature Range | 0 to 50°C (32 to 122°F) continuous [for use >50 C, up to 70 C, consult factory for special conditions and considerations] | |
| Allowable Sensor Temperature | 90°C (194°F) non-continuous | |
| BOS3 Sensor Specifications - Liquid Phase / Gas Phase | | |
| | Gas Phase Oxygen @ 1atm, 20°C | |
| Measurement Range | 0 - 300 ppm with over-range of 1000 ppm | |
| Limit of Detection (LOD) | 0.5 ppm O ₂ | |
| Resolution @ 20°C & 1013 hPa | 10 ± 0.5 ppm; 100 ± 0.8 ppm; 200 ± 1.5 ppm | |
| Response Time (T₉₀) | < 3 sec. based on 0 - 300 ppm measurement range | |
| Accuracy @ 20°C, 1 atm | ± 2ppm or ± 5% of measured value whichever is greater (or as partial pressure, +/- 0.002 hPa) | |
| Drift from Photo-decomposition | < 1.5 ppm within 30 days (1 min sample rate) | |
| Operating Temperature Range | 0 to 50°C (32 to 122°F) continuous | |
| Allowable Sensor Temperature | 90°C (194°F) non-continuous | |
| Cross Sensitivity for BOS1, BOS2, BOS3 Sensors Listed above | | |
| No cross-sensitivity for carbon dioxide (CO ₂), hydrogen sulfide (H ₂ S), ammonia (NH ₃), gaseous sulfur dioxide (SO ₂), no cross-sensitivity to pH (1-14), ionic species like sulfide, sulfate or chloride. Usable in methanol, ethanol-water mixtures, and in pure methanol & ethanol. Avoid organic solvents like benzene, chloroform, toluene, acetone, and methylene chloride along with any strong oxidizers such as gaseous chlorine (Cl ₂). | | |

Precision Optical Oxygen Measurement

OXYvisor™ Oxygen Analyzer

OXYvisor Configuration

| Analyzer | Power | Agency Approval | Sensor Style | Mounting Orientation | Conduit Entries | |
|--|--|---|----------------------|-------------------------------------|---------------------|--|
| OXYvisor Base Model Number Prefix | | | | | | |
| BOA | "Barben Oxygen Analyzer" - OXYvisor | | | | | |
| Input Power | | | | | | |
| DC | 22 to 26.5 VDC, 5W (4-wire, line powered analyzer, this is NOT a loop powered analyzer. Requires two wires for DC power and two separate wires for 4-20 mA output) | | | | | |
| AC | 85 to 260* VAC, 47-63 Hz, 6 W (4-wire, line powered analyzer), (*Zone 1 and CID2 can be up to 264 V) | | | | | |
| Agency Approval | | | | | | |
| 1 | Class I Zone 1 | CE Ex II 2 G | Ex db op is IIC | T4 Gb | ATEX - | |
| | | IEC IECEx | Ex db op is IIC | T4 Gb | IEC / EU - | |
| | | Class I Zone 1 | AEx db op is IIC | T4 Gb | US (NEC 505) - | |
| | | Class I Zone 1 | Ex db op is IIC | T4 Gb | CA (CEC Section 18) | |
| 2 | Class I Division 2 | Group A, B, C, D | T4a | US (NEC 500) and CA (CEC Annex J18) | | |
| 3 | Class I Division 2 | CE Ex II 3 G | Ex ec [ic] op is IIC | T4 Gc | ATEX | |
| | | IEC IECEx | Ex ec [ic] op is IIC | T4 Gc | IEC / EU | |
| Sensor Style | | | | | | |
| | SFP | Standard Fiber Patch | | | | |
| Mounting Orientation | | | | | | |
| | B | Junction Box placed below main enclosure, fiber optic exits bottom (as shown) | | | | |
| Conduit Entries | | | | | | |
| | SI | 25 mm Conduit Entries | | | | |
| | AM | 3/4" FNPT Conduit Entries | | | | |
| Analyzer | Power | Agency Approval | Sensor Style | Mount Orientation | Conduit Entries | |
| BOA | DC | 2 | SFP | B | AM | Typical Analyzer Model Number (Example) |

OXYvisor Accessories

| Part Number | Description |
|-------------|---|
| B5008-1225 | Wall Mount Kit - 316 SS |
| B5008-1125 | Pipe Mount Kit - 316 SS (1-1/2" - 2-1/4" pipe) |
| B5600-1185 | Compact USB memory stick for data logging and firmware upgrades, 8 GB |
| B5008-1140 | Compact sunshade, outdoor use, GRP 7.67"Wx13.98"Dx3.7"H, 316SS Back Plate, 316SS Collar Mount |
| B5500-0025 | Trace Level - AutoCal Kit: Test Gas Bottles (N6 & 25 ppm), analytical grade regulators, pipe/wall stand for bottles, (requires AutoCal SCP) [customer supplied 1/4" 316 SS tubing required] |
| B5500-0050 | Trace Level - AutoCal Kit: Test Gas Bottles (N6 & 50 ppm), analytical grade regulators, pipe/wall stand for bottles, (requires AutoCal SCP) [customer supplied 1/4" 316 SS tubing required] |
| B3905-1100 | RS485 Modbus Cable USB (PC) to 2 Wire OXYvisor connection cable 5m |
| B4951-1142 | Plug 3/4" MNPT CI D1&2 |
| B5003-0002 | 316 SS Tag |

Precision Optical Oxygen Measurement

OXYvisor™ Oxygen Analyzer

OXYvisor Analyzer Overview

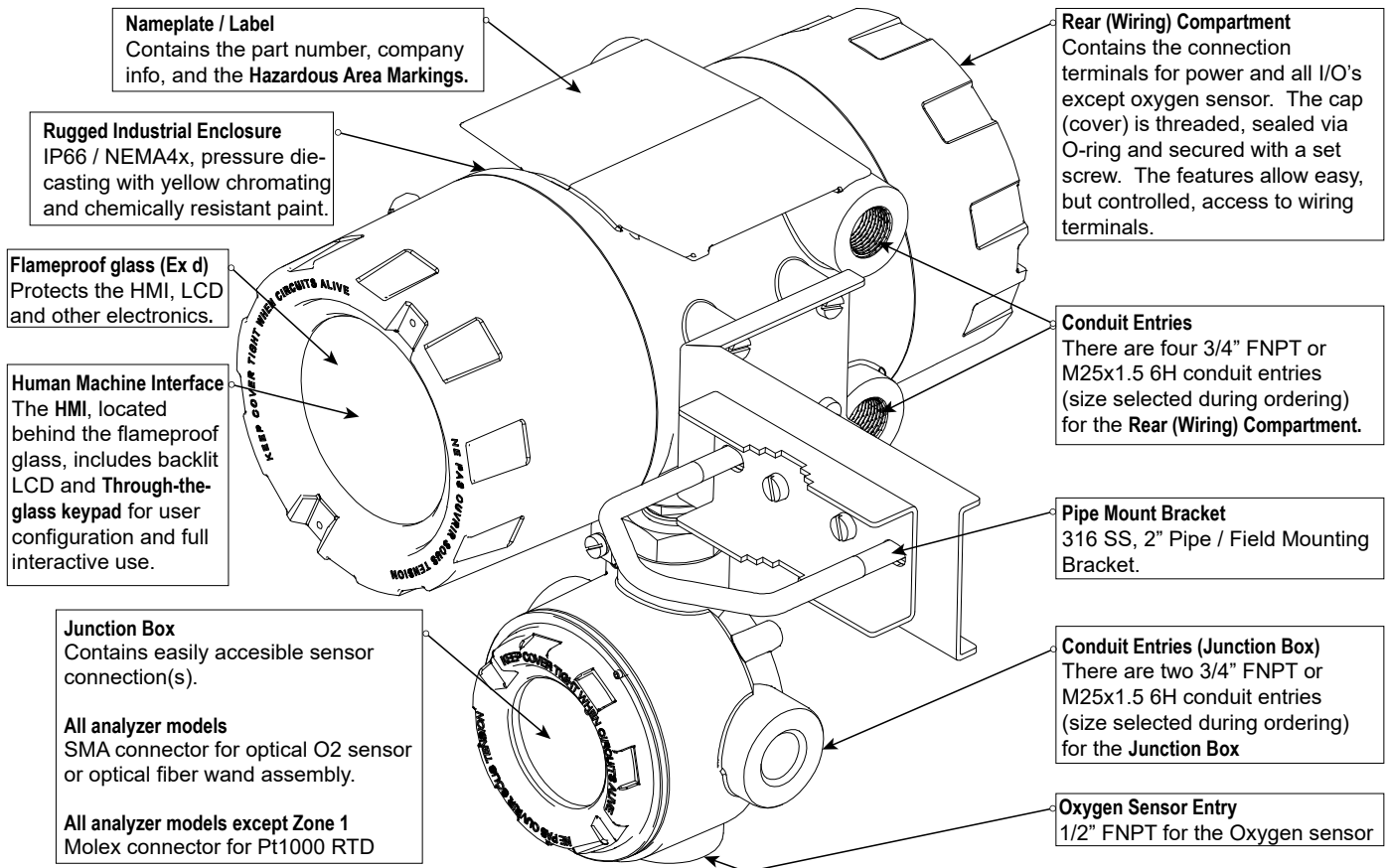

Figure 5

OXYvisor Installation Examples

BOSx Sensor with Integral RTD (Recommended for Liquid Phase Measurement)

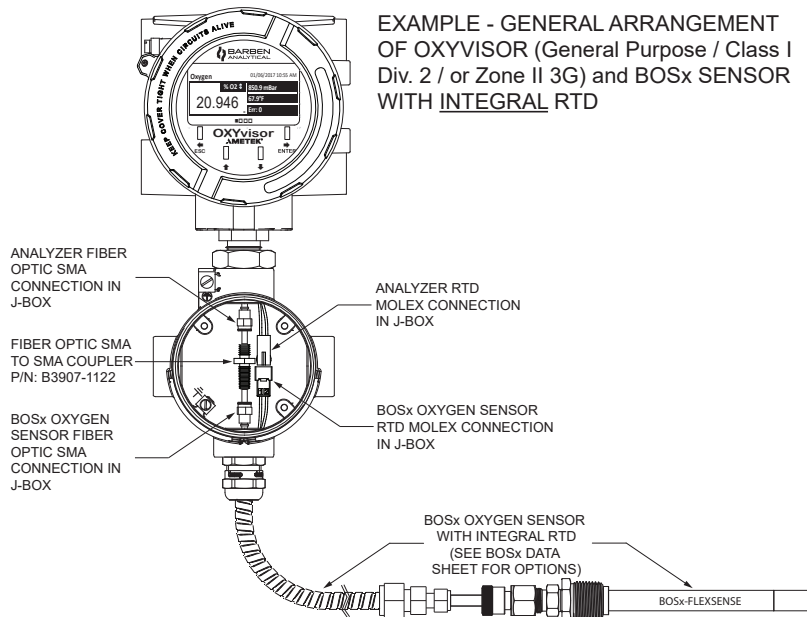

Figure 6

Precision Optical Oxygen Measurement

OXYvisor™ Oxygen Analyzer

Installation Examples

BOSx Sensor with External RTD (Recommended for Gas Phase Measurement)

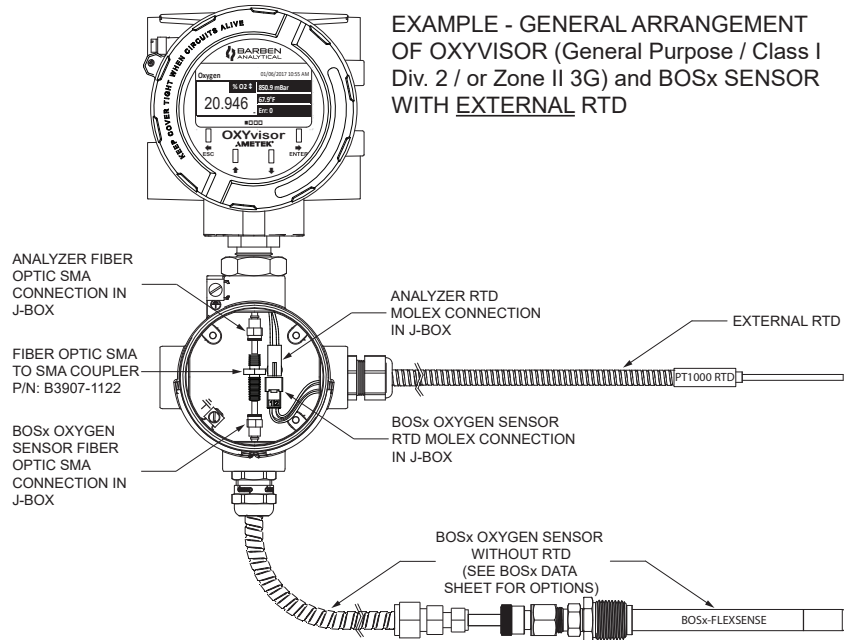

Figure 7

BOSx Sensor with External RTD (Gas Phase Measurement in Exd Area)

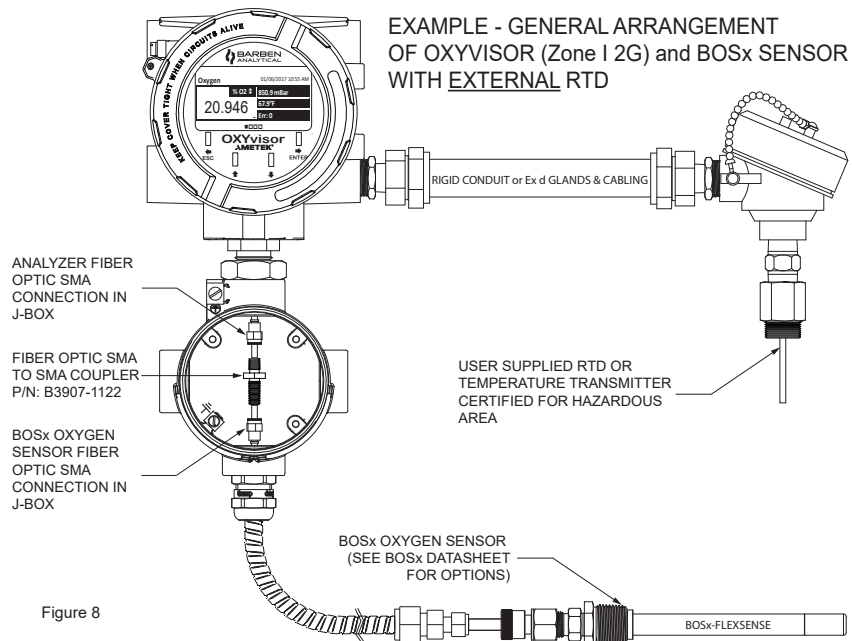
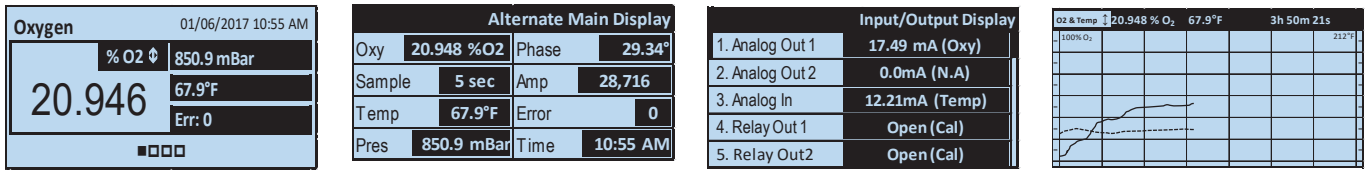

Figure 8

Precision Optical Oxygen Measurement

OXYvisor™ Oxygen Analyzer

MAIN DISPLAY (FOUR VIEWING OPTIONS)



ESC ← TO ENTER SUB-MENUS

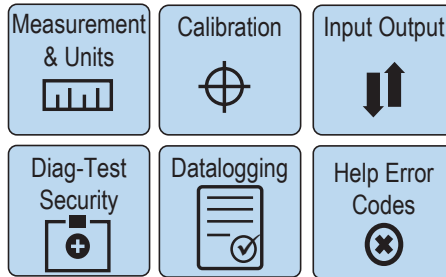

SUB-MENU OPTIONS

Figure 9

OXYvisor Software

Quick configuration, troubleshooting, trending and datalogging of the analyzer measurements can be easily accomplished through the OXYvisor Software. The software utilizes the MODBUS RTU protocol to communicate with the analyzer.

Oxygen measurements, temperature, pressure and sensor characteristics such as phase angle and amplitude can be captured on the screen simultaneously or via a .csv file on the host computer.

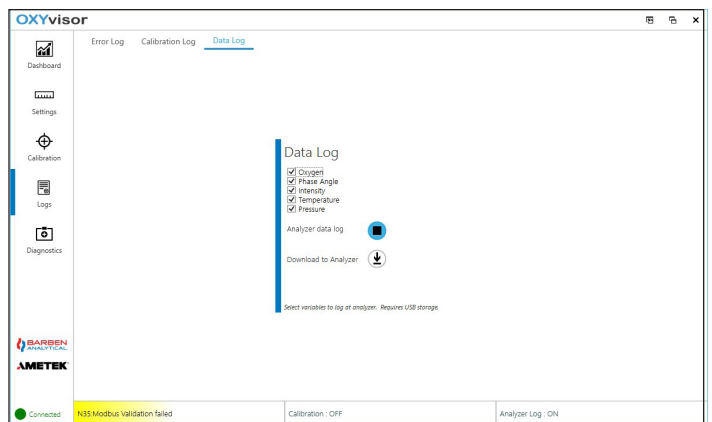
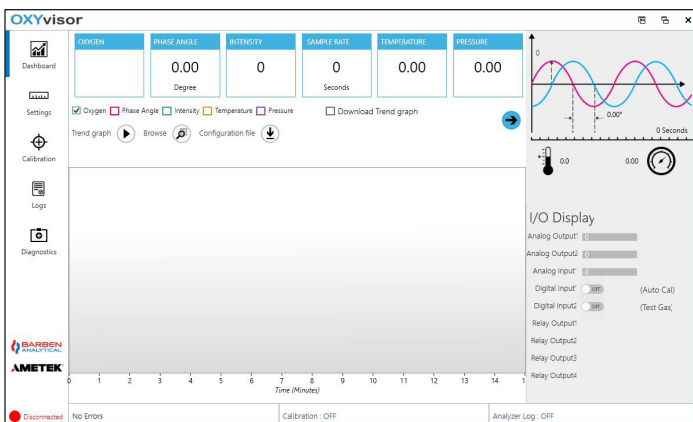
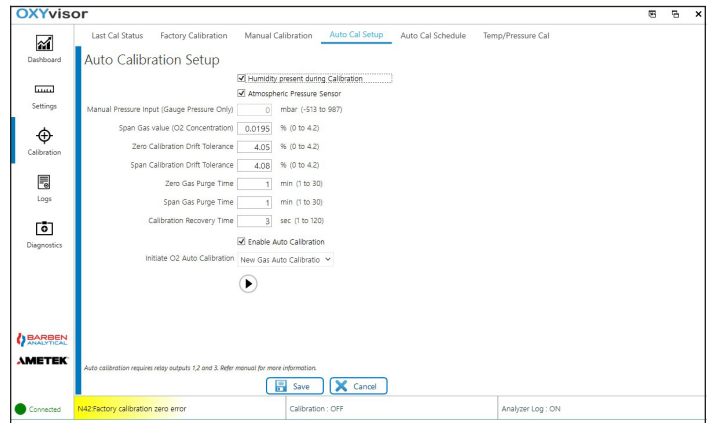

Precision Optical Oxygen Measurement

OXYvisor™ Oxygen Analyzer

The device has been tested and approved for use in hazardous areas via a third party OSHA approved NRTL

The **OXYvisor** is certified as Process Control Equipment for use in hazardous locations (QUZW, QUZW7) Class I, Division 2



Class I, Division 2, Groups A, B, C, D T4A

US NEC Standards UL 12.12.01, CAN CEC Standards CSA C22.2 No. 213-17

The **OXYvisor** is certified as Process Control Equipment for use in Zone 1, Group IIC

ATEX Zone 1, Group IIC Markings:



II 2 G Ex db op is IIC T4 Gb

Ta = -20° C to +55° C

Certificate Number: DEMKO 19 ATEX 2031, issued by UL DEMKO International A/S

EN Standards: 60079-0, 60079-1, 60079-28

IECEx Zone 1, Group IIC Markings:



Ex db op is IIC T4 Gb

Ta = -20° C to +55° C

Certificate Number: IECEx UL 19.0040 issued by UL LLC

IEC Standards: 60079-0, 60079-1, 60079-28

North America Zone 1, Group IIC Markings (QVAJ/QVAJ7):



Class I Zone 1 AEx db op is IIC T4 Gb

Ta = -20° C to +55° C

Ex db op is IIC T4 Gb

Ta = -20° C to +55° C

The **OXYvisor** is certified as Process Control Equipment for use in Zone 2, Group IIC

ATEX Zone 2, Group IIC Markings:



II 3 G Ex ec [ic] op is IIC T4 Gc

Ta = -20° C to +55° C

Certificate Number: DEMKO 19 ATEX 2036, issued by UL DEMKO International A/S

EN Standards: 60079-0, 60079-7, 60079-11, 60079-28

IECEx Zone 2, Group IIC Markings:



Ex ec [ic] op is IIC T4 Gc

Ta = -20° C to +55° C

Certificate Number: IECEx UL 19.0072 issued by UL LLC

IEC Standards: 60079-0, 60079-1, 60079-28

The **OXYvisor** complies with the following directives and has passed applicable emissions/immunity testing



Electromagnetic Compatibility (EMC)
Low-voltage (Safety)
Potentially Explosive Atmospheres (ATEX)
RoHS

Directive 2014/30/EU
Directive 2014/25/EU
Directive 2014/34/EU
Directive 2011/65/EU

EMC Emissions:

EN 61326-1:2013 (IEC 61326-1:2012) Group 1 Class A, EN 61000-3-2:2014 (IEC 61000-3-2:2014), EN 61000-3-3:2013 (IEC 61000-3-3:2013)

EMC Immunity:

EN 61326-1:2013 (IEC 61326-1:2012) Group 1, Class A, EN 61000-4-2:2009 (IEC 61000-4-2:2009), EN 61000-4-3:2006/A1:2008/A2:2010 (IEC 61000-4-3:2006+A1+A2), EN 61000-4-4:2004/A1:2010 (IEC 61000-4-4:2004+A1), EN 61000-4-5:2006 (IEC 61000-4-5:2006), EN 61000-4-6:2009 (IEC 61000-4-6:2009), EN 61000-4-8:2010 (IEC 61000-4-8:2010), EN 61000-4-11:2004 (IEC 61000-4-11:2004)

Contact Us

Barben Analytical is a leading supplier of analytical measurement technology targeting the industrial marketplace. It is a wholly owned subsidiary of Ametek. Ametek has nearly 14,000 colleagues at over 120 manufacturing locations around the world. Supporting those operations are more than 80 sales and service locations across the United States and in more than 30 other countries around the world.

Barben Analytical reserves the right to make technical changes or modify the contents of this document without prior notice. We reserve all rights in this document and in the subject matter and illustrations contained within.

© 2024, by AMETEK, Inc. All rights reserved • BA-DAT-OXY-AN-24R5



TF: +1-800-993-9309 • P: +1-775-883-2500 • F: +1-775-883-6388
E: Sales.Barben@Ametek.com • W: BarbenAnalytical.com

